

KENWOOD

AM/FM STEREO RECEIVER

KR-A4040

INSTRUCTION MANUAL

KENWOOD CORPORATION

B60-0855-08 © (K, P, E, M, X) MC

Introduction

Your choice of this product indicates that you are a devotee to excellence in sound reproduction.

We appreciate your patronage and take pride in the long tradition of quality components that our company represents.

So that you can get the most out of your unit, we suggest that you take the time to read through this manual before you hook up and operate your system. This will acquaint you with operating features and system-connection considerations so that your listening pleasure will be enhanced right from the start. You will notice that in all aspects of planning, engineering, styling, operating convenience and adaptability we have sought to anticipate your needs and desires.

Keep this manual handy for future reference.

For your records

Record the serial number, found on the back of the unit, in the spaces designated on the warranty card, and in the space provided below. Refer to the model and serial numbers whenever you call upon your dealer for information or service on this product.

Model _____ Serial Number _____

Unpacking

Unpack the unit carefully and make sure that all accessories are put aside so they will not be lost.

Examine the unit for any possibility of shipping damage. If your unit is damaged or fails to operate, notify your dealer immediately. If your unit was shipped to you directly, notify the shipping company without delay. Only the consignee (the person or company receiving the unit) can file a claim against the carrier for shipping damage.

We recommend that you retain the original carton and packing materials for use should you transport or ship the unit in the future.

For the U.S.A.

Note to CATV system installer:

This reminder is provided to call the CATV system installer's attention to Article 820-40 of the NEC that provides guidelines for proper grounding and, in particular, specifies that the cable ground shall be connected to the grounding system of the building, as close to the point of cable entry as practical.

Accessories

FM indoor antenna 1 AM loop antenna..... 1

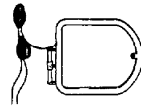
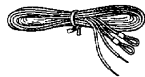

Loop antenna holder ... 1 75 Ω /300 Ω antenna adaptor 1
(For the U.K. and Europe only)



AC plug adaptor 1
(Except for some areas)
For the unit with a European AC plug in areas other than Europe.

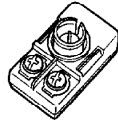

Contents

Caution: Read the pages marked  carefully to ensure safe operation.

Introduction	2	FM DE-EMPHASIS/CHANNEL SPACE switch	9
▲ Before applying power	3	Controls and indicators	10
▲ Safety precautions	3	Operating instructions	11
▲ IMPORTANT SAFEGUARDS	4	Listening to broadcasts	13
System connections	6	In case of difficulty	15
Speaker connections	7	Specifications	16
Antenna connections	8		

⚠ Caution: Read this page carefully to ensure safe operation.

Before applying power

For the U.S.A. and Canada

Important!

Units shipped to the U.S.A. and Canada are designed for operation on 120 volts AC only.

CAUTION: TO PREVENT ELECTRIC SHOCK DO NOT USE THE AC PLUG WITH AN EXTENSION CORD, RECEPTACLE OR OTHER OUTLET UNLESS THE BLADES CAN BE FULLY INSERTED TO PREVENT BLADE EXPOSURE.

For the United Kingdom

Important!

Units shipped to the U.K. are designed for operation on 240 volts AC only.

The mains plug must be removed from the wall socket prior to any internal examination.

The wires in this mains lead are coloured in accordance with the following code:

Blue Neutral
Brown Live

The wires in this mains lead must be connected to the terminals in the plug as follows:

Wire colour **Plug terminal marking**
Blue N or Black
Brown L or Red

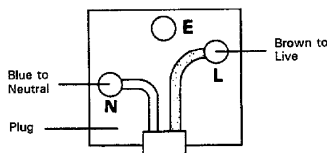

Notes:

1. If a 13-amp plug is used, this must be fitted with a 5-amp fuse.
2. If a 3-pin plug with earthing contact is used, no wire must be connected to the E terminal.

For Australia and Europe

Important!

Units shipped to Australia are designed for operation on 240 V AC only.

Units shipped to Europe are designed for operation on 230 V AC only.

For other countries

Important!

Units shipped to countries other than the above countries are equipped with an AC voltage selector switch on the rear panel. Refer to the following paragraph for the proper setting of this switch.

AC voltage selection

This unit operates on 110-120 or 220-240 volts AC. The AC voltage selector switch Type A or Type B on the rear panel is set to the voltage that prevails in the area to which the unit is shipped. Before connecting the power cord to your AC outlet, make sure that the setting position of this switch matches your line voltage. If not, it must be set to your voltage in accordance with the following direction.

Note:

Our warranty does not cover damage caused by excessive line voltage due to improper setting of the AC voltage selector switch.

AC voltage selector switch

Type A

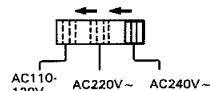



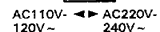

Type B



Move switch lever to match your line voltage with a small screwdriver or other pointed tool.

Safety precautions

WARNING: TO PREVENT FIRE OR ELECTRIC SHOCK, DO NOT EXPOSE THIS APPLIANCE TO RAIN OR MOISTURE.

 <div style="border: 1px solid black; padding: 2px; text-align: center;"> CAUTION <small>RISK OF ELECTRIC SHOCK DO NOT OPEN</small> </div> 	<p>CAUTION: TO REDUCE THE RISK OF ELECTRIC SHOCK, DO NOT REMOVE COVER (OR BACK). NO USER-SERVICEABLE PARTS INSIDE, REFER SERVICING TO QUALIFIED SERVICE PERSONNEL.</p>
	<p>THE LIGHTNING FLASH WITH ARROWHEAD SYMBOL, WITHIN AN EQUILATERAL TRIANGLE, IS INTENDED TO ALERT THE USER TO THE PRESENCE OF UNINSULATED "DANGEROUS VOLTAGE" WITHIN THE PRODUCT'S ENCLOSURE THAT MAY BE OF SUFFICIENT MAGNITUDE TO CONSTITUTE A RISK OF ELECTRIC SHOCK TO PERSONS.</p>
	<p>THE EXCLAMATION POINT WITHIN AN EQUILATERAL TRIANGLE IS INTENDED TO ALERT THE USER TO THE PRESENCE OF IMPORTANT OPERATING AND MAINTENANCE (SERVICING) INSTRUCTIONS IN THE LITERATURE ACCOMPANYING THE APPLIANCE.</p>

IMPORTANT SAFEGUARDS

⚠ Caution : Read this page carefully to ensure safe operation.

Please read all of the safety and operating instructions before operating this unit. For best results, follow all warnings placed on the unit and adhere to the operating and use instructions. These safety and operating instructions should be retained for future reference.

1. Power sources — The unit should be connected to a power supply only of the type described in the operating instructions or as marked on the appliance.

2. Power-cord protection — Power-supply cords should be routed so that they are not likely to be walked on or pinched by items placed upon or against them, pay particular attention to cords at plugs, convenience receptacles, and the point where they exit from the unit.

Never pull or stretch the cord.



3. Grounding or polarization — The precautions should be taken so that the grounding or polarization means of this unit is not defeated.

4. Ventilation — The unit should be situated so that its location or position does not interfere with its proper ventilation.

To maintain good ventilation, do not put records or a table-cloth on the unit. Place the unit at least 10 cm away from the walls.

Do not use the unit on a bed, sofa, rug or similar surface that may block the ventilation openings.



5. Water and moisture — The unit should not be used near water — for example, near a bathtub, washbowl, kitchen sink, laundry tub, in a wet basement, or near a swimming pool, etc.

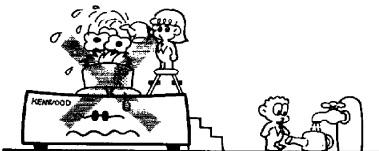

6. Temperature — The unit may not function properly if used at extremely low, or freezing temperatures. The ideal ambient temperature is above +5°C (41°F).

7. Heat — The unit should be situated away from heat sources such as radiators, heat registers, stoves, or other units (including amplifiers) that produce heat.

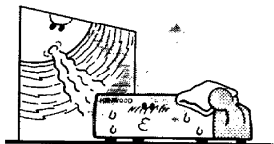

8. Electric shock — Care should be taken so that objects do not fall and liquid is not spilled into the enclosure through openings. If a metal object, such as a hair pin or a needle, comes into contact with the inside of this unit, a dangerous electric shock may result. For families with children, never permit children to put anything, especially metal, inside this unit.

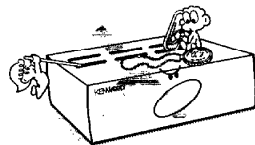

9. Enclosure removal — Never remove the enclosure. If the internal parts are touched accidentally, a serious electric shock might occur.

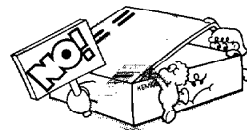

10. Magnetic fields — Keep the unit away from sources of magnetic fields such as TV sets, speaker systems, radios, motorized toys or magnetized objects.

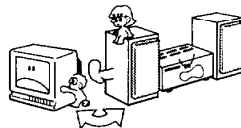

11. Cleaning — Do not use volatile solvents such as alcohol, paint thinner, gasoline, or benzene, etc. to clean the cabinet. Use a clean dry cloth.

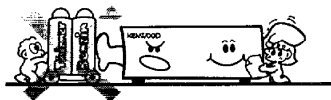

⚠ Caution : Read this page carefully to ensure safe operation.

12. Carts and stands — An appliance and cart combination should be moved with care. Quick stops, excessive force, and uneven surfaces may cause the appliance and cart combination to overturn.



13. Nonuse periods — The power cord of the unit should be unplugged from the outlet when left unused for a long period of time.

14. Abnormal smell — If an abnormal smell or smoke is detected, immediately turn the power OFF and pull out the power cord. Contact your dealer or nearest service center.

POWER OFF!



15. Damage requiring service — The unit should be serviced by qualified service personnel when:

- A. The power-supply cord or the plug has been damaged; or
- B. Objects have fallen, or liquid has been spilled into the unit; or
- C. The unit has been exposed to rain; or
- D. The unit does not appear to operate normally or exhibits a marked change in performance; or
- E. The unit has been dropped, or the enclosure damaged.

16. Servicing — The user should not attempt to service the unit beyond that described in the operating instructions. All other servicing should be referred to qualified service personnel.

17. Outdoor antenna grounding — If an outside antenna is connected to the receiver, be sure the antenna system is grounded so as to provide some protection against voltage surges and built up static charges. Section 810 of the National Electrical Code, ANSI/NFPA 70, provides information with respect to proper grounding of the mast and supporting structure, grounding of the lead-in wire to an antenna discharge unit, size of grounding con-

ductors, location of antenna-discharge unit, connection to grounding electrodes, and requirements for the grounding electrode. See Figure.

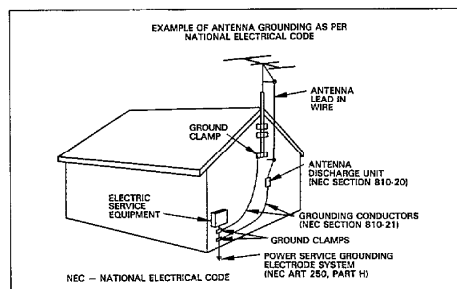

18. Power lines — An outdoor antenna should be located away from power lines.

19. AC outlets — Do not connect other audio equipment with a power consumption larger than that specified to the AC outlet on the rear panel. Never connect other electrical units, such as an iron or toaster, to it to prevent fire or electric shock.

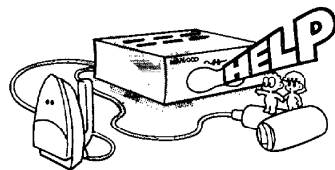

Notes:

- 1. Item 3 is not required except for grounded or polarized equipment.
- 2. Item 17 and 18 are not required except for units provided with antenna terminals.
- 3. Item 17 complies with UL in the U.S.A.

System connections

Make connections as shown in the diagram below.

When connecting the related system components, refer also to the instruction manuals of the related components.

Do not plug in the power lead until all connections are complete.

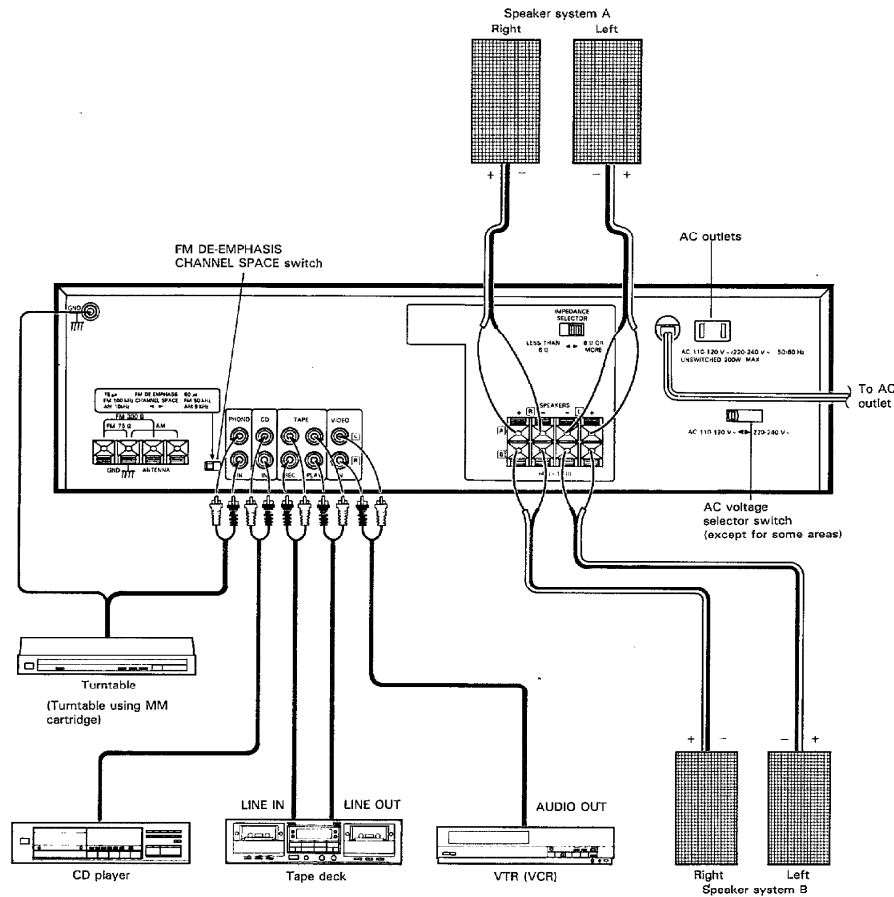

Notes:

1. To prevent possible problems, always disconnect the power plug or turn off the POWER switch of the receiver before connecting or disconnecting the audio cables.
2. When connecting audio cables, always insert the pin plugs securely into the connecting jacks.
 - Insufficient insertion may result in no-sound problems or generation of noise.

Speaker connections

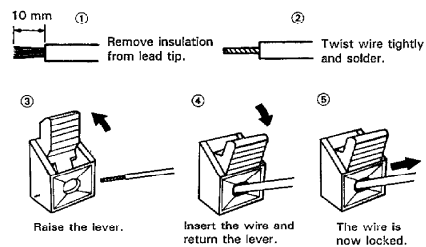

Speaker lead connection

Setting the speaker IMPEDANCE SELECTOR

When connecting one pair of speakers to the SPEAKERS A or B terminals, set the IMPEDANCE SELECTOR according to the speaker impedance.

When two pairs of speakers are connected to both the A and B terminals, match the speaker impedance selector to the speakers with the lowest impedance.

Notes:

1. During speaker system connection and operation of the speaker IMPEDANCE SELECTOR, set the POWER switch to OFF.
2. Check that the connected lead wires of the speaker systems do not contact with other jacks or terminals.

When using the speaker A or speaker B separately

Speaker impedance	Selector position
4Ω, 6Ω	A OR B: (BELOW 8Ω)
8Ω, 16Ω	(8Ω OR MORE)

When using the speakers A and B simultaneously

Speaker impedance	Selector position
8Ω, 16Ω	A AND B: (8Ω OR MORE)

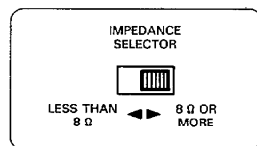

Connecting the speakers

Connect speakers rated at 4 ohm or more to the SPEAKERS terminals.

1. Connect the left speaker to the L speaker terminals on the rear of the receiver and the right speaker to the R terminals.
2. Connect each cable as shown in the illustration, taking care that the wires do not make contact with other terminals.

Notes:

1. Take care so as not to short the positive (+) and negative (-) speaker cords.
2. If the left and right speakers, or positive and negative cables, are connected the wrong way, the reproduced sound may be unclear, with ambiguous location of the musical instruments etc. To avoid this, pay attention to the left and right and positive and negative indications when connecting the speakers.

AC outlets

The AC outlets on the rear panel may be used to supply power to other components in the system, such as turntables, tape decks, etc. Never connect equipment whose power consumption exceeds the maximum value shown at each outlet.

UNSWITCHED outlets:

The maximum total capacity is 200 watts, 1.6 A max.

Unit destination	Shape of the AC outlet
U.S.A. and Canada	
U.S. Military	× 1
U.K.	× 2
Europe	× 2
Other countries	× 1
Australia	× 1

EKD-0802

WARNING

Particular attention must be given to making good electrical contact at the receiver output and speaker terminals.

Poor or loose connections can cause sparking or burning at the terminals because of the very high power that the receiver can deliver.

■ AM loop antenna connection

The supplied antenna is for indoor use. Place it as far as possible from the main system, TV set, speaker cords and power cord, and set it to a direction which provides the best reception.

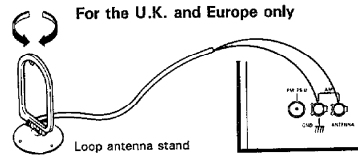
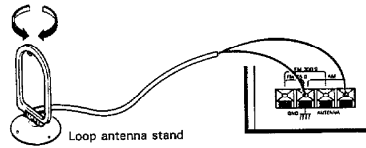

Connection method to each antenna terminal

- ① Push lever down. ② Insert conductor. ③ Return lever up.

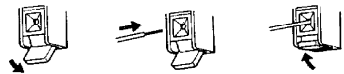

- ① Loosen the screw. ② Wrap the cord's conductor around. ③ Tighten the screw.

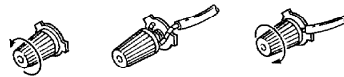

■ AM outdoor antenna connection

If the reception is poor when the AM loop antenna is used, distribute a vinyl-coated wire of more than 6 meters outdoors, without disconnecting the loop antenna.

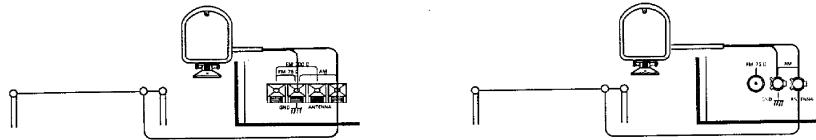

■ FM indoor antenna connection

The supplied antenna is for indoor use. For stable reception, remove the indoor antenna after installing an outdoor antenna as soon as possible.

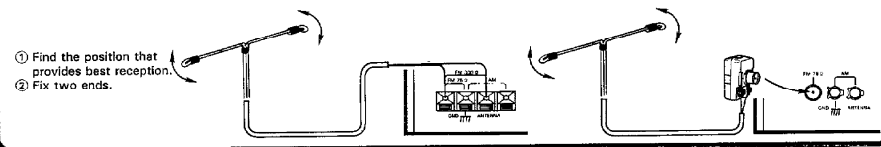

■ FM outdoor antenna connection

It is recommended to install an exclusive FM outdoor antenna to capture FM broadcasts with high sound quality. Use a coaxial cable for the connection between the outdoor antenna and FM ANTENNA terminal on the rear panel. For the connection between the coaxial cable and FM ANTENNA terminal, please refer to the illustration.

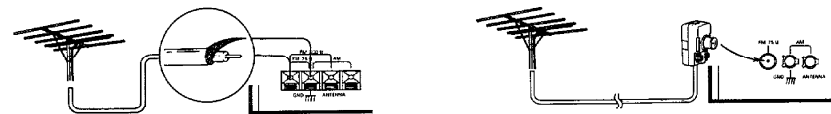

■ 75 Ω coaxial cable connection (For the U.K. and Europe)

① Arrange the coaxial cable as illustrate.

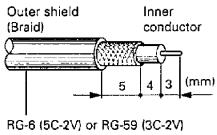

Outer shield (Braid) Inner conductor
5 4 3 (mm)
RG-6 (5C-2V) or RG-59 (3C-2V)

② Open the 75 Ω/300 Ω antenna adaptor.

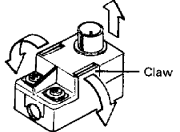

Claw

③ Cut off the red wire and remove it from the clip.

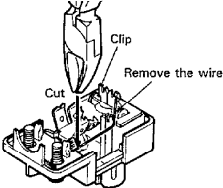

Clip
Cut
Remove the wire

④ Insert into the slit on the clip. Fasten the bands A and B, using a pair of pliers.

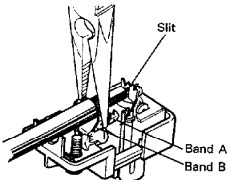

Slit
Band A
Band B

⑤ Close the cover.

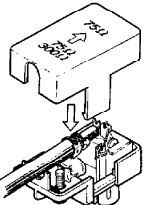

⑥ Connect the adaptor to the antenna terminal.

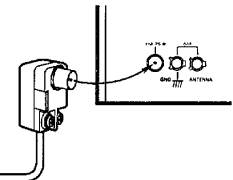

ANTENNA

FM DE-EMPHASIS/CHANNEL SPACE switch (Except for some areas)

The FM DE-EMPHASIS/CHANNEL SPACE switch on the rear panel is set to the correct setting that prevails in the area to which the unit is shipped. However, if the FM DE-EMPHASIS/CHANNEL SPACE setting is not matched to the area where the unit is to be used; for instance, when you moved from area 1 to area 2 or vice versa, desired reception of AM/FM broadcasts is not expected. In this case, change the FM DE-EMPHASIS/CHANNEL SPACE setting in accordance with the area corresponding to the table. The FM DE-EMPHASIS is switched over at the same time.

Area	CHANNEL SPACE freq.	FM DE-EMPHASIS
1. U.S.A., Canada, Hawaii, South American countries	FM: 100kHz AM: 10kHz	75 μs
2. Other countries	FM: 50kHz AM: 9kHz	50 μs

- When changing the setting of the FM DE-EMPHASIS/CHANNEL SPACE switch, first disconnect the power cord of the amplifier, then reset the channel space switch, connect the power cord again and turn the power on while pressing the TUNER key.

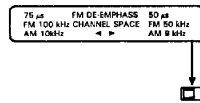

Controls and indicators

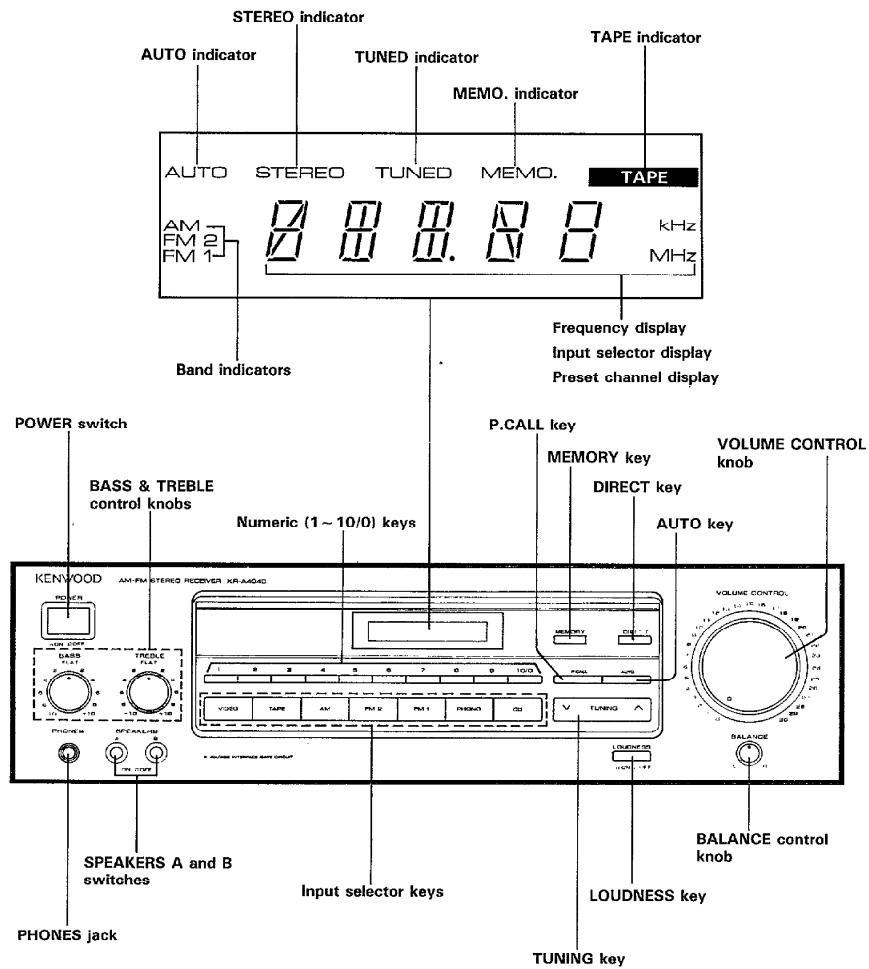

SPEAKERS A and B switches

- A, B OFF** — This position silences all speakers to permit private use of headphones.
- A ON** — Activates speakers connected to the SPEAKERS A terminals on the rear panel.
- B ON** — Activates the speakers connected to the SPEAKERS B terminals on the rear panel.
- A, B ON** — Activates the speakers connected to the SPEAKERS A and B terminals simultaneously.

Note:

When two pairs of speakers are connected to both A and B terminals simultaneously, use the speakers having an impedance of 8 to 16 ohms. In this case, connecting a speaker having an impedance of less than 8 ohms may cause malfunction of the amplifier.

Operating instructions

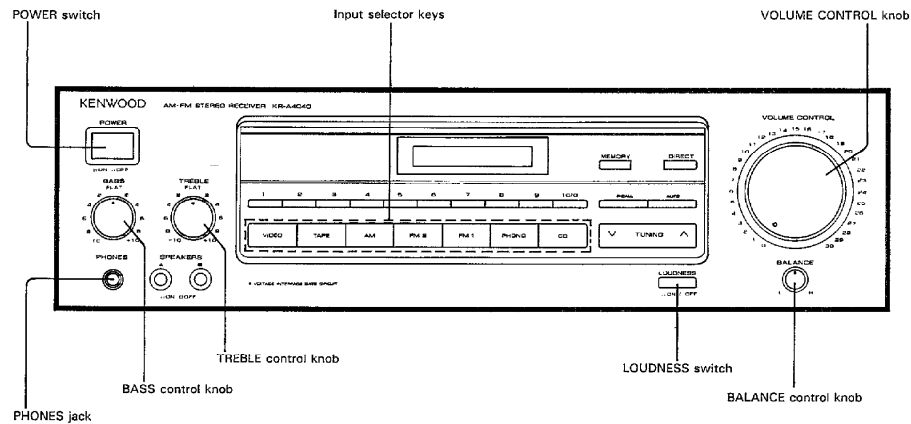

■ Basic operation

1. Press the **POWER** switch to **ON**.
 - The display lights, and the unit becomes operative.
 - Pressing the key again switches the power **OFF**.
2. Press one of the **input selector keys** to select the input source to be played.
 - The selected input source is shown on the display.
3. Start playing the source component selected.
4. Adjust the output level with the **VOLUME CONTROL** knob.
5. Adjust the balance of the left and right output levels with the **BALANCE** control knob.
6. Adjust the tone (**BASS**, **TREBLE**) for your preference.

Note:
When the **TAPE** selector switch is set to **ON**, the input source selected with the input selector keys cannot be heard from the speakers. To listen to a source other than tape deck, be sure to set the **TAPE** selector key to **OFF**.

■ Principal key function

Tone control knobs (**BASS**) (**TREBLE**)

Adjust tone controls to suit your taste.

BALANCE control knob

If an imbalance occurs (the left or right channel appears louder than the other) due to source imbalance or room acoustics, adjust **BALANCE** control to equalize the sound from both speakers.

LOUDNESS switch

If you customarily listen at low listening levels, set the **LOUDNESS** switch to **ON**. If not, set it to **OFF** position.

PHONES jack

This jack accepts the standard stereo headphone plug. When you wish to listen through headphones alone, set the **SPEAKERS** switches (A and B) both to the **OFF** (□) position.

Operating instructions

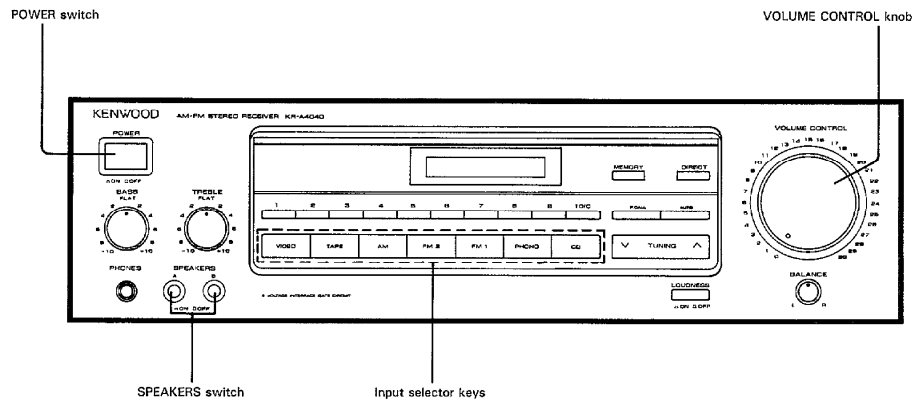

■ To record an input source

1. Press the **POWER** switch to **ON**.
2. Select the source to be recorded with the input selector keys.
3. Play the source.
4. Set tape deck to record mode.

■ To listen to radio broadcasts

1. Press the **POWER** switch to **ON**.
2. Press the input selector key (**FM1**, **FM2** or **AM**).
3. Tune in the desired broadcasting station according to the instructions in the "Tuning methods" section on page 13.
 - During tuning, sound is not heard because the muting circuit is activated. The sound will be heard suddenly as soon as a station is received, so be careful in setting the sound volume level.
4. When the desired station is received, adjust the volume with the **VOLUME CONTROL** knob.

Listening to broadcasts

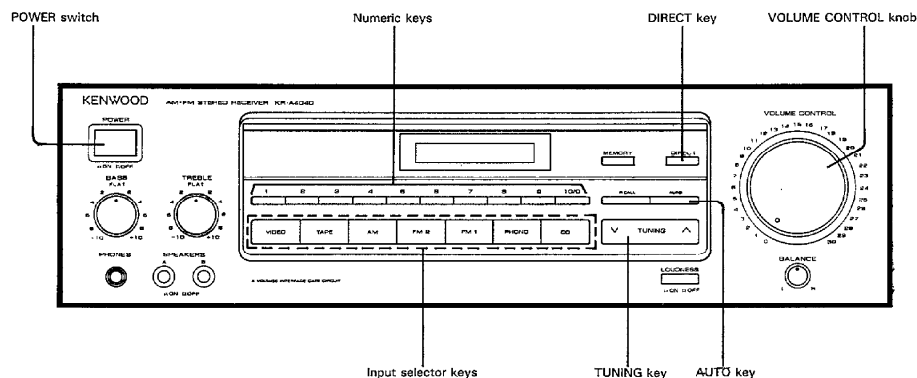

■ Tuning methods

Auto tuning

When the TUNING key is pressed, broadcast frequencies are scanned automatically in the upward or downward direction until a station is located and tuned in. The stereo/monaural FM reception mode is set automatically according to the station.

1. Press the **AUTO** key so that the **AUTO** indicator lights.
2. Press the **^ (UP)** or **∨ (DOWN)** segment of the **TUNING** key.

- Press the **^ (UP)** segment scans broadcast frequencies by varying the displayed frequencies in the upward direction, and pressing the **∨ (DOWN)** segment scans by varying the frequencies in the downward direction.
- When a broadcasting station is received, the frequency display freezes and indicates the frequency of the received station.

3. If the received station is not the desired station, press the same segment of the **TUNING** key again.

- Repeat this unit the desired station is received.

Manual tuning

Stations with weak signal strength cannot be received by auto tuning. In such cases, tune in the desired station by manual tuning. The station will be received in monaural mode (monaural mode is resistant to noise).

1. Press the **AUTO** key so that the **AUTO** indicator is off.
2. Press the **^ (UP)** or **∨ (DOWN)** segment of the **TUNING** key.

- Every time the TUNING key is pressed, the displayed frequency varies by one step in the direction indicated by the pressed segment.
- Holding the TUNING key depressed varies the displayed frequency continuously.

3. When the frequency of the desired station is tuned in, release the **TUNING** key.

- Noise may be heard if the tuned frequency is not precisely the same as the frequency of the station. In such cases, press the **^ (UP)** or **∨ (DOWN)** segment of the TUNING key to adjust the tuning precisely.

Direct tuning

This method allows the desired frequency to be entered directly using the numeric keys, without using the TUNING key.

1. Press the **DIRECT** key.
2. Enter the frequency of the desired station with the numeric keys.

- When all of the digits of the frequency have been entered, the station is automatically received.
- If the entered frequency is not in the receivable frequency range, the frequency display blinks for 5 seconds, and the last station received is received again.

Listening to broadcasts

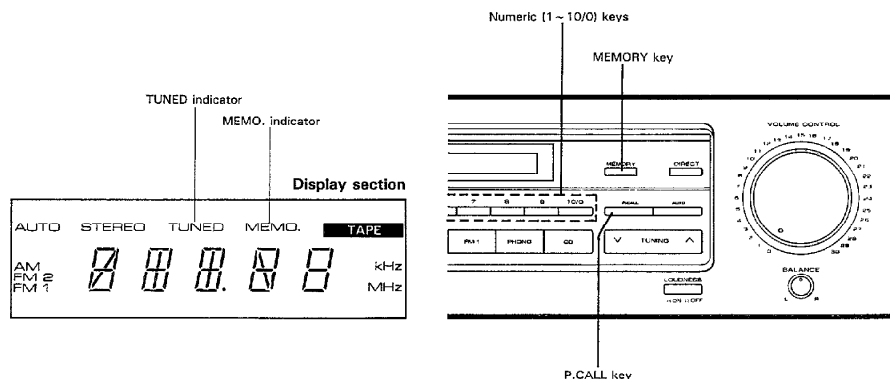

■ Preset tuning

By storing the frequencies of broadcasting stations in the preset channels according to the instructions in the "To preset station frequencies" section, any of the preset stations can be received by one-touch operation.

Press the numeric key corresponding to the preset channel of the desired station.

- The display shows the frequency of that station, and the station is received.

[Example] Display in case a preset channel is recalled

When numeric key "1" is pressed:

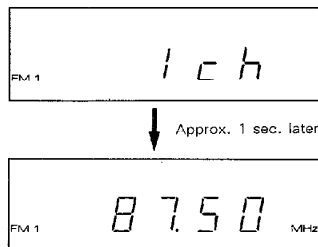

- The similar display also appears in the preset operation.
- The same display also appears when the FM 1, FM 2 or AM key is pressed.

■ To preset station frequencies

1. Press the input selector key for the desired band (FM1, FM2 or AM).
2. Tune in the desired station following the instructions in the "Tuning methods" section.
3. Press the MEMORY key.
 - The [MEMO.] indicator on the display lights.
4. Within 5 seconds after pressing the MEMORY key, press the numeric key (1 to 10/0) corresponding to the preset channel in which the frequency is to be stored.
 - If a frequency has already been stored under the selected preset channel, the previously-stored frequency will be replaced by the new frequency.
5. Preset all desired frequencies by repeating steps 1 to 4 above.

■ Preset Scan

This function allows the preset stations stored in the preset channels to be received in sequence for 5 seconds each.

1. Press the P.CALL key.
 - The frequency of each preset station is received for 5 seconds in sequence. A preset channel in which no station has been preset is skipped, and the scan operation moves to the next preset channel.
2. To stop Preset Scan, press the P.CALL key again.
 - The preset station being received when the key is pressed is received continuously.

In case of difficulty

If your unit should not perform as expected, consult the table below to see if the problem can be corrected before seeking help from your dealer or service representative.

Symptom	Cause	Remedy
No power, no sound.	<ul style="list-style-type: none"> Power cord not plugged in. Poor connection at wall outlet. Power outlet inactive. 	<ul style="list-style-type: none"> Check plug contact. Check outlet using a lamp or other appliance (outlet may be controlled by a wall switch).
No sound from left and right.	<ul style="list-style-type: none"> Speaker cords disconnected. Speakers switched off. 	<ul style="list-style-type: none"> Check speaker connections. Check speaker switch.
Sound from left or right, but not both.	<ul style="list-style-type: none"> Poor speaker connections. Defective speaker. 	<ul style="list-style-type: none"> Check connections at both ends of speaker cord. Reverse speakers, if problem stays with speaker, have speaker checked.
FM broadcast too noisy. Sufficient reception is impossible.	<ul style="list-style-type: none"> Indoor antenna is used. Poor connection of the antenna cable. 	<ul style="list-style-type: none"> Use an outdoor antenna. Connect the antenna cable correctly.
Occurs during AM reception only	Cause	Remedy
High-frequency whistle especially at night.	<ul style="list-style-type: none"> Interference from TV set. 	<ul style="list-style-type: none"> Turn off TV set. If problem disappears, try relocating TV set.
Intermittent buzz or cracking sound.	<ul style="list-style-type: none"> Lighting. Fluorescent lamps starting. Appliance or furnace starting. 	<ul style="list-style-type: none"> No remedy. Try reversing AC plug. Try reversing AC plug.
Occurs during FM reception only	Cause	Remedy
Hiss that gets worse in stereo reception.	<ul style="list-style-type: none"> Very weak antenna input signal. 	<ul style="list-style-type: none"> Consider an outdoor antenna installation. In areas remote from the transmitter, a 5 to 8 element antenna designed exclusively for FM is suggested.
Phythmic static or popping noises.	<ul style="list-style-type: none"> Automobile ignition noise, especially evident when receiving weak signals. 	<ul style="list-style-type: none"> Review antenna installation. Site the antenna as far from the street as possible and use coaxial cable.
STEREO indicator falls to light during stereo broadcast.	<ul style="list-style-type: none"> Another possible effect of a very weak signal. 	<ul style="list-style-type: none"> Antenna system needs attention (See above).

Notes:

- As this system uses microcomputers, it is open to interference from external noise, and may sometimes not function properly. In such a case, unplug the power cord once, and then plug it in again.
- Do not use contact cleaner because it could cause a malfunction. Be specially careful against contact cleaners containing oil, for they may deform the plastic components.

For the U.S.A.

FCC WARNING:

This equipment may generate or use radio frequency energy. Changes or modifications to this equipment may cause harmful interference unless the modifications are expressly approved in the instruction manual. The user could lose the authority to operate this equipment if an unauthorized change or modification is made.

Specifications

Except for Europe and U.K.

AUDIO SECTION

Rated Power Output
(For the U.S.A. & Canada)

50 watts per channel minimum RMS, both channel driven at 8 Ω , from 30 Hz to 20,000 Hz with no more than 0.09% total harmonic distortion. (FTC)

(For other than the U.S.A. & Canada)

(IHF '66) From 20 Hz to 20 kHz, 0.09% T.H.D., at 8 Ω 55 W + 55 W

Total Harmonic Distortion 0.09% (30 Hz~20 kHz, 50 W, 8 Ω)

Input Sensitivity/Impedance

PHONO (MM) 2.5 mV/47 k Ω
CD, TAPE, VIDEO 200 mV/47 k Ω

Frequency Response

CD 10 Hz~50 kHz + 0 dB, -3 dB

Signal to Noise Ratio (IHF-A)

PHONO (MM) 76 dB for 6 mV input
CD, TAPE, VIDEO 100 dB for 200 mV input

Tone Controls

BASS ± 10 dB (at 100 Hz)
TREBLE ± 10 dB (at 10 kHz)

FM TUNER SECTION

Tuning Frequency Range 87.5 MHz~108 MHz

Antenna Impedance... 300 Ω balanced & 75 Ω unbalanced

Sensitivity (IHF) 10.8 dBf (0.95 μ V at 75 Ω)

50 dB Quietening Sensitivity

MONO 16.2 dBf (3.5 μ V at 75 Ω)
STEREO 38.2 dBf (45 μ V at 75 Ω)

Signal to Noise Ratio at 65 dBf (IHF)

MONO 79 dB
STEREO 73 dB

Total Harmonic Distortion at 1,000 Hz (IHF)

MONO 0.3%
STEREO 0.5%

Stereo Separation (IHF at 1 kHz)..... 45 dB

Frequency Response... 30 Hz~15 kHz + 0.5 dB, -2.0 dB

AM TUNER SECTION

Tuning Frequency Range

9 kHz step 531 kHz~1,602 kHz
10 kHz 530 kHz~1,610 kHz
(The U.S.A. and Canada) 530 kHz~1,700 kHz

Usable Sensitivity 12 μ V (400 μ V/m)

Signal to Noise Ratio 50 dB

Total Harmonic Distortion 0.5%

Selectivity 23 dB

GENERAL

Power Consumption...1.3 A (The U.S.A. and Canada Models)
120 W (IEC) (Others)

Dimensions 440 (W) x 129 (H) x 284 (D) mm
(17-5/16" x 5-1/16" x 11-3/16")

Weight (Net) 5.5 kg (12.1 lb)

For Europe and U.K.

AUDIO SECTION

Rated power output

(IEC) from 63 Hz to 12,500 Hz
0.7% T.H.D. at 8 Ω 55 W + 55 W
(DIN) 1,000 Hz at 8 Ω 50 W + 50 W
at 4 Ω 50 W + 50 W

Total Harmonic Distortion

..... 0.09% (40 Hz~20 kHz, 25 W, 8 Ω)

Input Sensitivity/Impedance

PHONO (MM) 2.5 mV/47 k Ω
CD, TAPE, VIDEO 200 mV/47 k Ω

Frequency Response

CD 10 Hz~50 kHz + 0 dB, -3 dB

Signal to Noise Ratio (DIN weighted, at 50 mW output)

PHONO (MM) 56 dB
CD, TAPE, VIDEO 57 dB

Tone Controls

BASS ± 10 dB (at 100 Hz)
TREBLE ± 10 dB (at 10 kHz)

FM TUNER SECTION

Tuning Frequency Range 87.5 MHz~108 MHz

Antenna Impedance 75 Ω unbalanced

Sensitivity (DIN)

(MONO) 1.3 μ V
(STEREO) 40 μ V

Total Harmonic Distortion

(DIN at 1 kHz, 65.2 dBf input)

MONO 0.3%
STEREO 0.4%

Signal to Noise Ratio (DIN weighted at 1 kHz, 65.2 dBf input)

MONO 68 dB
STEREO 61 dB

Stereo Separation (DIN at 1 kHz) 40 dB

Frequency Response... 30 Hz~15 kHz + 0.5 dB, -2.0 dB

AM TUNER SECTION

Tuning Frequency Range 531 kHz~1,602 kHz

Usable Sensitivity 12 μ V/(400 μ V/m)

Signal to Noise Ratio 50 dB

Total Harmonic Distortion 0.5%

Selectivity 22 dB

GENERAL

Power Consumption 120 W

Dimensions 440 (W) x 129 (H) x 284 (D) mm

Weight (Net) 5.5 kg

Note: KENWOOD follows a policy of continuous advancements in development. For this reason specifications may be changed without notice.